

Job Name: \_\_\_\_\_  
 Location: \_\_\_\_\_  
 Engineer: \_\_\_\_\_  
 Submitted to: \_\_\_\_\_  
 Submitted by: \_\_\_\_\_  
 Reference: \_\_\_\_\_

Date: \_\_\_\_\_  
 Approval: \_\_\_\_\_  
 Construction: \_\_\_\_\_  
 Unit #: \_\_\_\_\_  
 Drawing #: \_\_\_\_\_

## CASSETTE FEATURES:

- 

**SWING LOUVER**  
 CHV ceiling cassettes and wall mounts include louvers which swing automatically for even air distribution.
- 

**HUMIDITY SENSOR (OPTIONAL)**  
 The optional humidity sensor allows access to more precise dehumidification control.
- 

**EASY MAINTENANCE**  
 CHV indoor units provide convenient access to filters and other important components for easy upkeep and increased longevity.
- 

**AUTO FAN SPEED**  
 Fan speed rotation is automatically controlled to achieve optimum efficiency and comfort.
- 

**AUTO RESTART**  
 The automatic restart function sets the indoor units to automatically restart and resume previous settings in the event of a power outage.
- 

**FRESH AIR INTRODUCTION**  
 Fresh air can be directed into rooms with an optional adapter or direct connection to the air return segment of the unit.
- 

**WiFi ADAPTER (OPTIONAL)**  
 An optional WiFi adapter can be installed to enable system control via iOS or Android smart device for up to 64 indoor units.
- 

**COMPACT SIZE**  
 Compact indoor units can be conveniently transported and installed, even in small spaces.
- 

**LOW TEMPERATURE COOLING**  
 The target temperature of indoor units can be set as low as 60°F.
- 

**SILENT OPERATION**  
 CHV units create minimal sound pressure during operation.
- 

**48-INCH DRAINAGE HEIGHT**  
 Some CHV indoor models are equipped with a drain pump to pull condensation upward and remove water from the units with a drainage height of up to 48 inches.

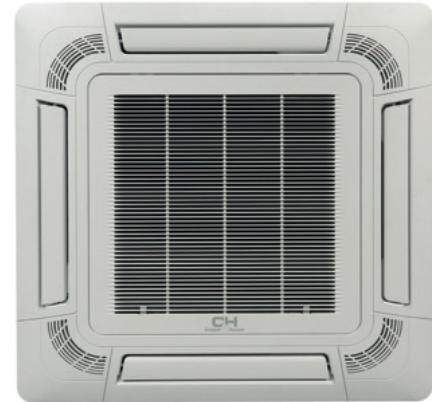

- 

**WIDE CAPACITY RANGE**  
 CHV indoor units come in a wide range of capacities across 5 different indoor model types.
- 

**ADJUSTABLE LOUVER POSITION**  
 CHV indoor units feature adjustable louvers for more precise directional air flow.
- 

**REMOTE CONTROL**  
 Indoor units can be controlled with wireless remote controller featuring an LCD display.
- 

**FAN SPEED**  
 6 Selectable fan speeds.
- 

**STANDARD FILTER INCLUDED**  
 A washable, long-life filter is included as a standard part.
- 

**SELF-DIAGNOSIS**  
 CHV indoor units use the self-diagnosis function to monitor and analyze malfunctions. Error codes are displayed on LED displays, remote controllers, or PCB boards as a general troubleshooting guide.

## Optional Accessories:

- Receiver kit - SPWRK-T03
- Wired controller - SPWT-A01
- Drain Pump - SPIDP-DHP07/24
- Motion Sensor - SPHNS-S01E
- Wireless controller - SPRC-101
- Wired controller - SPWT-C01
- Drain Pump - SPEDP-DHP07/54
- Humidity Sensor - SPHDS-S01E

Model name			CHV-48SCC4W
Cooling capacity	Nominal capacity	Btu/h	47,800
	Input power	kW	0.13
Heating capacity	Nominal capacity	Btu/h	54,600
	Input power	kW	0.13
Power supply		V, Ph, Hz	208/230V, 1Ph, 60Hz
Max/Min power supply		V	253/188
Electrical parameters	MCA	A	2.15
	MOP	A	15
Dimensions (H x W x D)		in	11 1/2 x 33 5/4 x 33 5/4
Connection pipe diameter	Low pressure gas pipe	in	5/8"
	Liquid pipe	in	3/8"
Condensate drain		in	1-1/4"
Refrigerant			R410A
Net weight		lbs	57
Air flow rate		CFM	1321/1196/1057/971/864/800
Sound pressure level		dB(A)	46/44/40/38/36/34

**NOTES:**

1. The nominal cooling capacity is the combined capacity of the Cooper&Hunter standard split system.

Cooling operation conditions: Indoor air inlet temperature: 80°F DB 66°F WB, Outdoor air inlet temperature: 95°F DB.

Heating operation conditions: Indoor air inlet temperature: 68°F DB, Outdoor air inlet temperature: 44°F DB, 42°F WB., Piping length: 24.6ft., Piping lift: 0ft.

2. The sound pressure level is based on the following conditions: 4.9ft beneath the unit with discharge Duct(6.5ft.) and Return Duct(3.3ft.). Voltage of the power source for the indoor fan motor is 208V. The above data was measured in an anechoic chamber so that reflected sound should be taken into consideration in the field.

3. The data for external pressure \*1) indicates standard pressure setting values when a filter is not used.

4. The above air flow rate and noise level are tested with AC 208V power supply and without filter screen.

Unit: inch (mm)

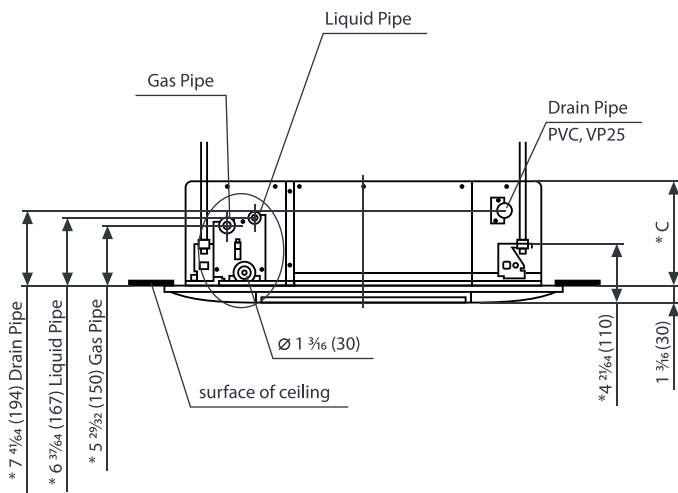
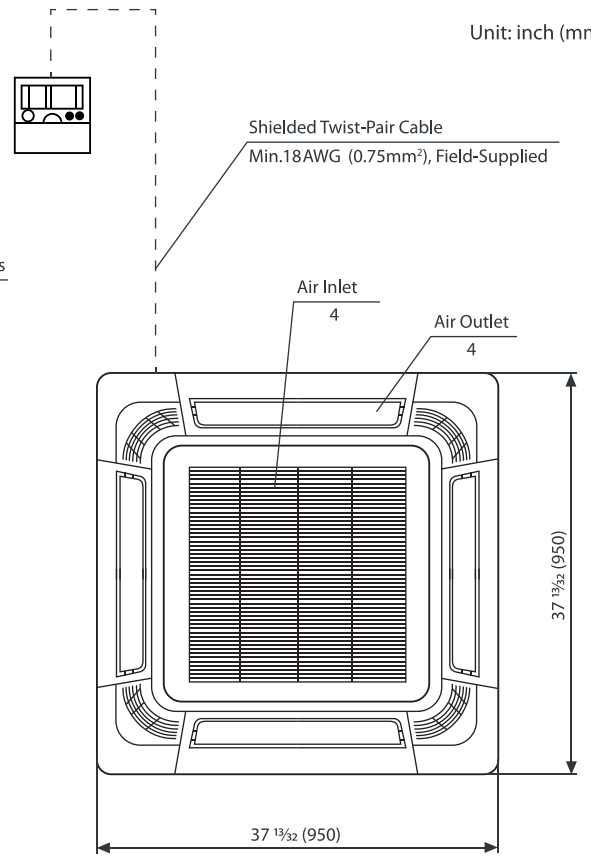
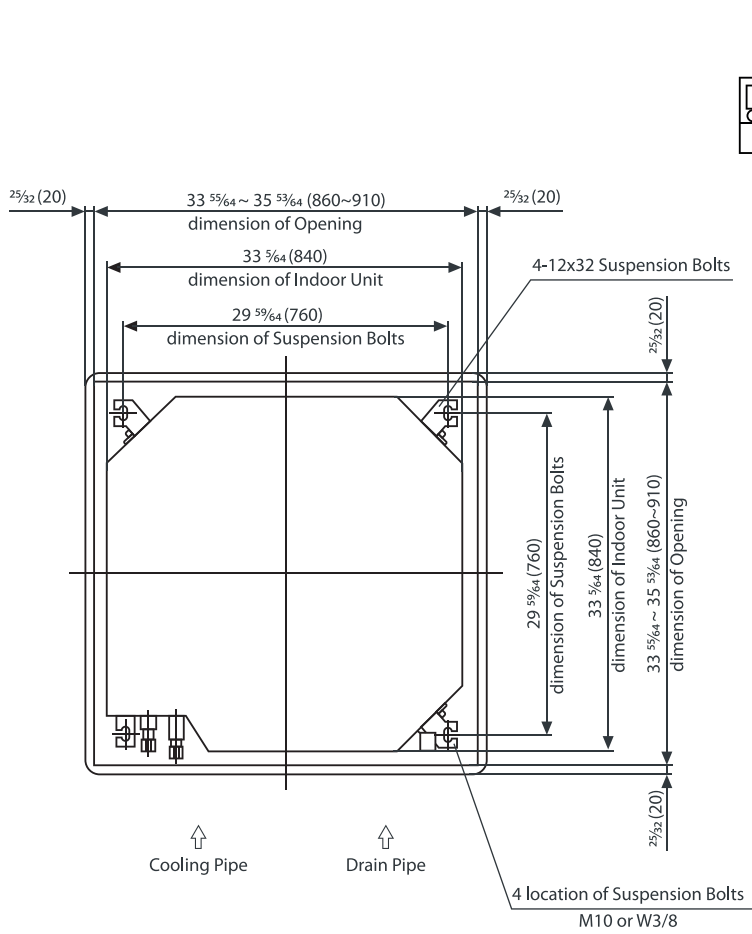

\* Confirm the distance between the bottom surface of indoor unit and the surface of ceiling.